



## MCharger Connected S 22 kW



**Installation and operating manual**

## About this manual

The installation and operating manual is intended for the electrician who carries out the installation as well as for the persons who are to operate the product.

Read the manual in full before starting to use the product.

Save the manual after reading for future reference.

This installation and operating manual is a part of the product.

If you pass on the product to third parties, please also pass on this manual and the accompanying documents.

## MARKING OF IMPORTANT NOTICES

Particularly important information is marked in this manual as follows:



### **DANGER!**

This warning alerts you of possible dangers in handling or operating the wallbox that may lead to serious injury or death.



### **WARNING!**

Warning alerts you of possible damage that can lead to minor injuries and damage to the wallbox if not avoided.



**INFORMATION!** Notes for the user



**NOTE** on an qualified electrician

## WARRANTY

Warranty claims can be made within a maximum period of 3 years, calculated from the date of purchase. The warranty is limited to the repair or replacement of the damaged component at our discretion. Our warranty is always free of charge. However, it does not apply if defects other than material and workmanship defects are detected.

We also grant a 12-month warranty on proper functioning. This warranty starts from the date of purchase.

## Table of contents

Introduction.....	1
Safety.....	1
General safety instructions .....	1
Qualification of personnel for installation and maintenance .....	2
User's qualification .....	2
Intended use.....	2
Service .....	3
Nameplate .....	3
Scope of delivery .....	4
Installation.....	5
Installation site requirements .....	5
Required tools .....	5
Installation of the wallbox.....	6
Connecting the power cable .....	17
Mounting the top cover .....	20
Setting up the wallbox.....	21
Connection .....	21
Enable automatic updates.....	23
Enable data transfer .....	23
Create users.....	24
User types.....	25
RFID cards/tags.....	25
General settings .....	26
Power reduction.....	26
Charging History .....	27
Loadbalancing.....	29
Master / Slave set-up .....	30
Master configuration.....	31
Slave configuration.....	31
Slave deactivation .....	31
Prioritization and load sharing .....	32
Ocpp .....	34
Operating instructions.....	35
General .....	35
Standby mode .....	35

Vehicle connected .....	36
Charging.....	37
End of charging.....	38
Maintenance, troubleshooting and decommissioning .....	39
Maintenance .....	39
Manual updates.....	39
Cleaning.....	39
Error diagnosis.....	39
Reset.....	41
Decommissioning .....	42
Disposal instructions .....	42
CE marking and declaration of conformity .....	43
Technical Data .....	44
Dimensions.....	45
Copyright .....	46
Contacts / SERVICE .....	46

## Introduction

Thank you for choosing our product! We have developed the MCharger together with the company Plastimat with the utmost care and we are of course also available to you after the purchase if you have any questions or problems.

This manual contains all the necessary information for the installation and operation of the wallbox. Please read it carefully to familiarize yourself with the functions of this product.

## Safety

### *General safety instructions*

Please read the warnings and notes in this guide.

Local regulations regarding operation, installation and environment must be followed and adhered to.



**DANGER! High electrical voltages are present in the wallbox.  
There is a danger to life!**

Store this manual carefully. The safety instructions must be available to every user.



**Please note that according to electricity grid operators', energy suppliers' or national requirements a reporting or approval obligation for the installation or the operation of a wallbox may be mandatory.**

**In Germany, there is a reporting obligation according to §19 NAV.**



**Please note that continuously occurring network disturbances can lead to malfunctioning of the wallbox. It may be necessary to restart the wallbox.**



**MCharger Connected is a radio equipment according to Radio Equipment Act (FuAG). The requirements described in this manual must be complied with in order for the radio equipment to be certified accordingly.**

**A change to the wallbox or use outside of the described requirements will void the certification.**

**The manufacturer assumes no liability for this.**

## ***Qualification of personnel for installation and maintenance***

Only suitably qualified specialist personnel (electrician) may install, commission, and maintain the wallbox.



**DANGER! Improper installation or repair of the wallbox can cause severe consequences, such as fire or severe or fatal injuries!**

## ***User's qualification***

Only adults are allowed to use this wallbox. They must familiarize themselves with the operation beforehand by studying these instructions.



**DANGER! Opening the housing is only permitted when the wallbox is in a voltage-free state and no vehicle is connected to it. The top cover may only be opened by an electrician as the it protects the user from access to high electrical voltages!**



**DANGER! If the wallbox is visibly damaged or has fallen, it must not be used. Please contact the installer or supplier.  
Do not carry out any unauthorized changes or repairs!**

## ***Intended use***

The wallbox is suitable for AC charging (mode 3) of an electric vehicle. A ventilation requirement, such as that required for charging lead-acid batteries, is recognized by the wallbox, charging does not take place in these cases.



**WARNING! No extension cables or adapters may be used.**



**DANGER! High electrical voltages are present in the wallbox.  
There is a danger to life!**

## Service

For technical service, please first contact the electrician who carried out the installation of the wallbox.

## Nameplate

The nameplate on the bottom of the MCharger wallbox shows all relevant data of the wallbox. Here you will find e.g., type designation, serial number, date of manufacture (month/year), as well as the operating parameters of the wallbox.



The nameplate may differ from the representation shown here.

## Scope of delivery

The wallbox is delivered in a custom-fit box. When unpacking, please make sure that you remove all parts from the box. If something is unexpectedly missing, please contact the supplier from whom you bought the wallbox immediately.



**NOTE: Check all parts for damage before the assembly.  
Damaged parts may not be installed!**

1 x Housing with pre-assembled lower cover and pre-assembled charging socket

1 x Top cover, not mounted

1 x Installation and operating manual in German

1 x Installation and operating manual in English

1 x Datasheet with access data

2 x RFID card for authentication

1 x Bag with

1 x Installation rail

5 x Screw 6 x 50 T30

5 x Dowel 8 mm

2 x Screw for top cover 3.5 x 12 T15

1 x Strain relief large

1 x Strain relief small

2 x Screw for strain relief 3.5 x 28 T15

1 x Rubber grommet black small

2 x Rubber grommet grey

1 x slotted cable inlet (1 x Inlay 6 mm, 1 x Inlay 2 x 6 mm)

1 x CAN bus mating connector

Please keep the packaging during the warranty period.



# Installation

## *Installation site requirements*

Please check if the installation location:

- is freely accessible and the wallbox display is easy to read even in incident light;
- offers the intended installation height of 0.5-1.5 m, measured from the lower edge of the wallbox;
- provides a sufficient load capacity;
- provides a flat and sufficiently dimensioned mounting surface;
- is not exposed to direct sunlight and the prescribed temperature range can be maintained;
- protects the wallbox from moisture and direct rain;
- is taking into account the minimum distances to other systems, namely sufficient space for the socket (>40 cm on the right side), as well as the legal requirements for electrical installations, fire protection, safety regulations and escape routes;
- does not pose a risk from flammable gases or vaporizing and/or flammable substances, as well as fuels or other flammable or explosive materials;
- does not expose the wallbox to vibrations;
- is not blocking any escape routes, or creating possible tripping points due to the charging cable lying around;
- is below an altitude of 2000 m;
- offers sufficient space for a safe passage between the wallbox and the vehicle and other objects.

If there is no electrical supply line for the building distribution at the desired installation location, it must be prepared by an electrician considering all the necessary parameters.

No items may be placed on the wallbox.



**WARNING! The wallbox may not be mounted or operated on ships.**

## *Required tools*

- Screwdriver T15 (for the cover and strain relief screws);
- Screwdriver T30 (for the wall screws);
- Flat-blade screwdriver (for breakthrough openings in the housing);
- Spirit level;
- Drilling machine;
- Drill bit 8 mm;
- Pencil;
- Combination pliers (for breakthrough opening at the top of the housing);
- Hammer (for breakthrough openings in the housing);
- Wire stripper.

## Installation of the wallbox



**WARNING! Only appropriately qualified specialists (electricians) may install the wallbox.**

The following steps show where special attention should be paid to when mounting on the wall. All length measures are shown in millimetres.

If the wallbox is not attached to a wall, please follow the instructions in the installation manual of the accessory.

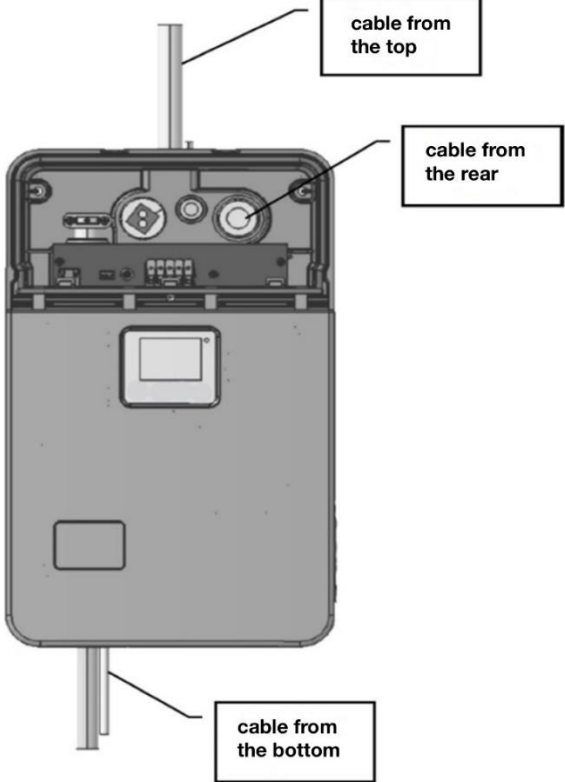
Preparation	
<p>If the top cover has already been set, remove it by carefully lifting the two tabs with a screwdriver.</p>	
<p>Select the cable entry according to the type of installation from:</p> <ul style="list-style-type: none"><li>• top</li><li>• bottom</li><li>• rear</li></ul>	

An additional cable of CAN interface can be inserted through the middle opening.

Break out the opening with the screwdriver and hammer, then deburr the area with a knife.



**WARNING!** Risk of injury due to sharp cutting edges when breaking out the openings.

Use the *small black rubber grommet* for sealing.



Please note that if the rubber grommets are not used, IP protection cannot be guaranteed.



### Cable from the bottom

The required opening is provided in the housing.

Use one of the two *gray rubber grommets* to seal the opening for the cable entry.



Please note that if the rubber grommets are not used, IP protection cannot be guaranteed.



## Cable from the top

Break out the opening on the top of the housing with the pliers and deburr it with a knife.



**WARNING!** Risk of injury due to sharp cutting edges when breaking out the openings.

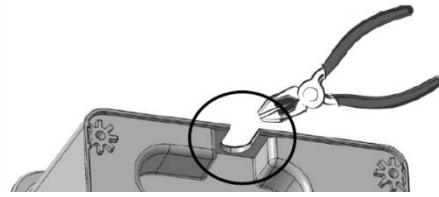

Use the free space to lay a drip loop.

Use one of the two *gray rubber* grommets to seal the opening for the cable entry.



Please note that if the rubber grommets are not used, IP protection cannot be guaranteed.



## Cable from the rear

Break out the opening on the back of the housing with a screwdriver and a hammer and then deburr it with a knife.



**WARNING!** Risk of injury due to sharp cutting edges when breaking out the openings.

Use one of the two *gray rubber* grommets to seal the opening for the cable entry.



**Please note that if the rubber grommets are not used, IP protection cannot be guaranteed.**

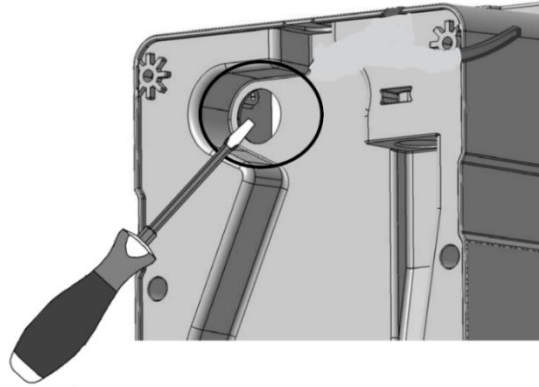

## Mounting the installation rail

After entering the cable, use the appropriate marking (small triangle) on the installation rail for the orientation.



**WARNING! Only upright installation of the wallbox is permitted, so the installation rail must be aligned horizontally.**

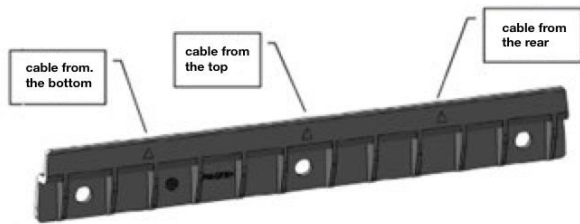

For the installation from the bottom, use the left side mark on the installation rail.

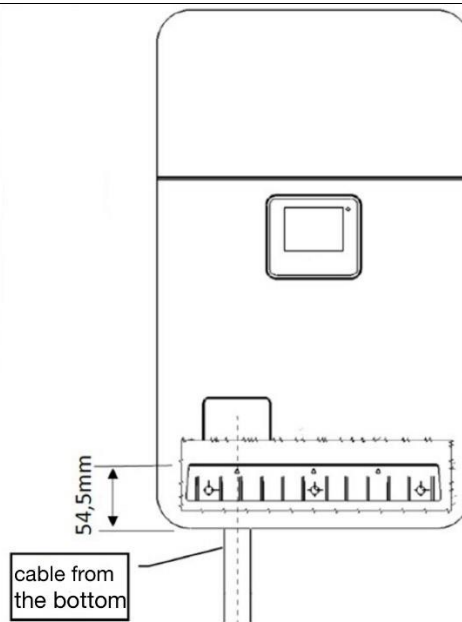

Draw the left mark.

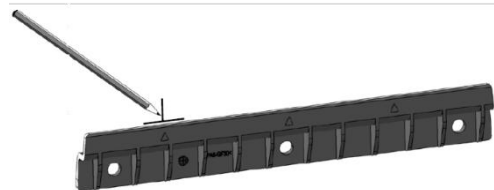

For the installation from the top, use the mark in the middle of the installation rail.

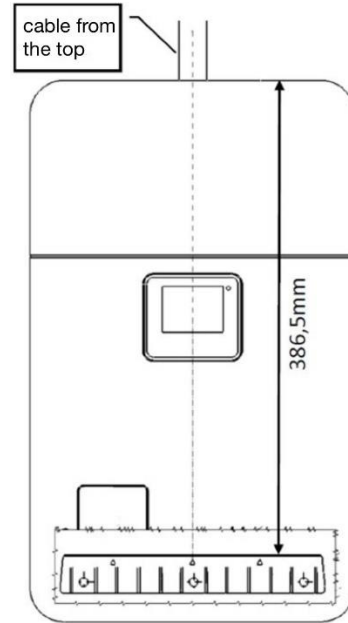

Draw the middle mark.

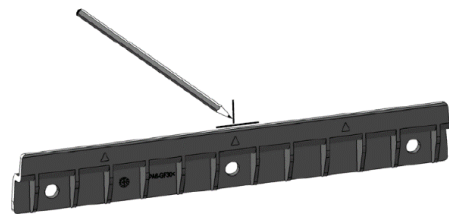

For the installation from the rear, use the right side mark on the installation rail.

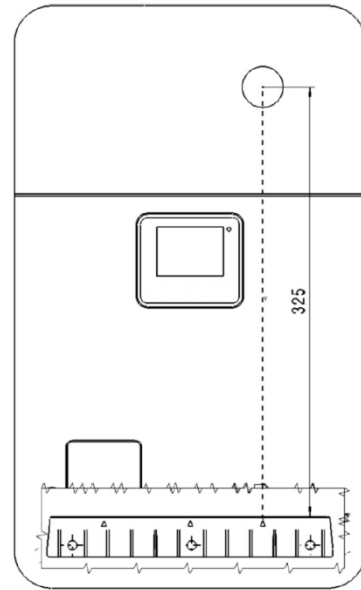

Draw the right mark.

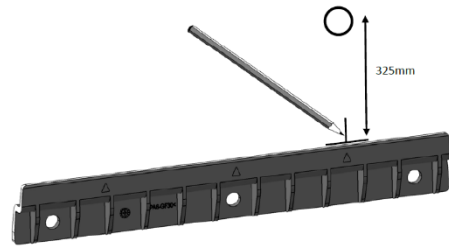

Mark the holes for the installation rail.

Use a spirit level!

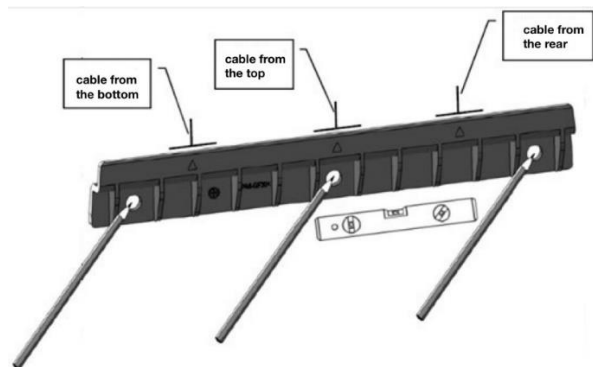



Use the supplied cylinder head screws and dowels.

Use a maximum screw diameter of 6 mm.

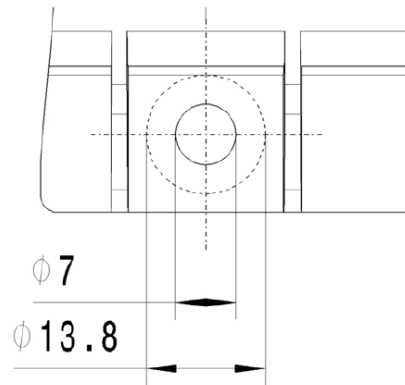

Drill the appropriate holes for the installation rail with a distance of 90 mm.

Use an 8 mm diameter drill bit.

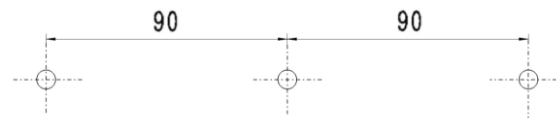

3x

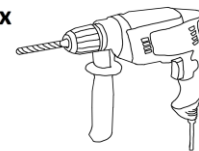

Attach the installation rail to the wall with dowels and screws.

Check the alignment again with the spirit level.

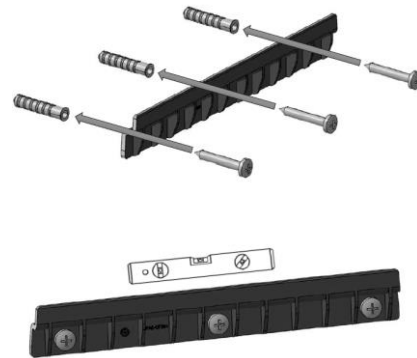

## Installation of the wallbox

Put the wallbox on the installation rail.

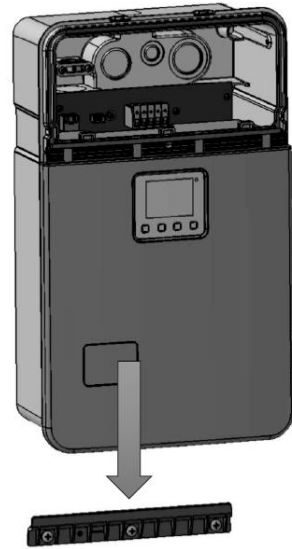

Press the wallbox firmly to the wall.

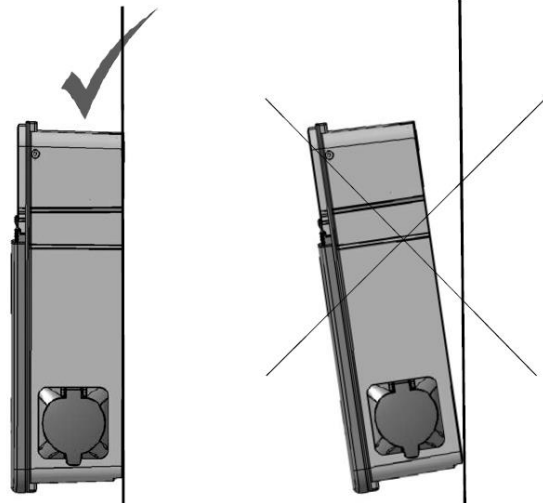

Draw the upper drill marks.

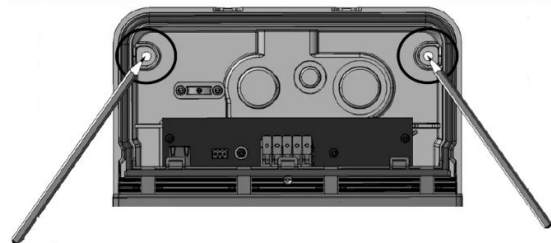

Use the supplied flathead screws and dowels.  
Use a maximum screw diameter of 6 mm.

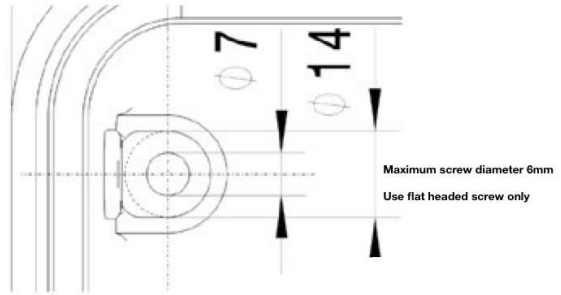

Remove the wallbox from the installation rail again.

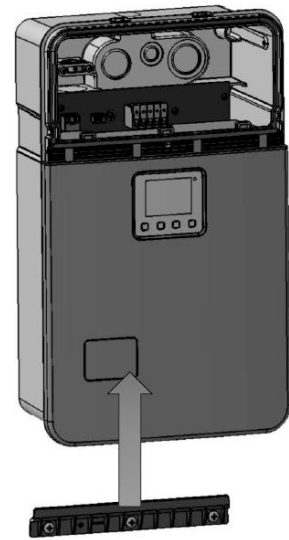

Drill the marked holes.  
Use an 8 mm diameter drill bit.

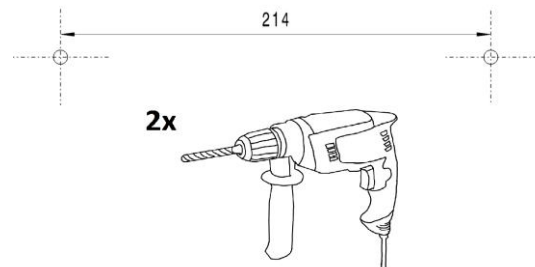

Mount the dowels.

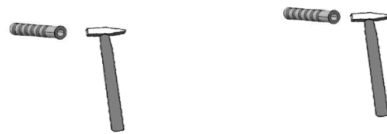

Insert the connection cable into the wallbox and use the appropriate *grey rubber grommet*.



**Please note that if the rubber grommets are not used, IP protection cannot be guaranteed.**

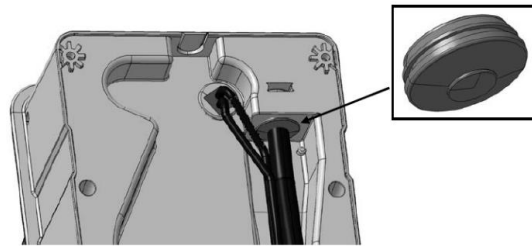

Put the wallbox on the installation rail.

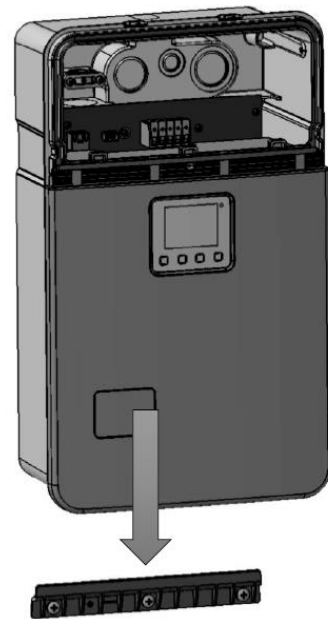

Secure the wallbox with two screws.

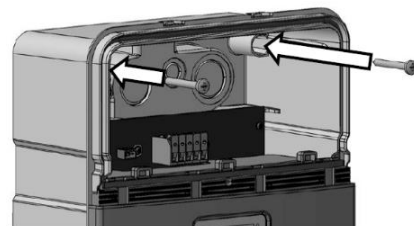

Use the *strain relief (small/large)* for the installation type "from the bottom" or "from the top" of the connection cable.

Select the size based on the cable diameter.

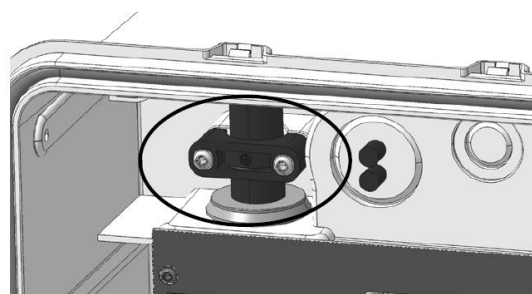

## Connecting the power cable



**WARNING!** The installation may only be carried out by a qualified electrician.



**WARNING!** Make sure again that the connection cable is disconnected from the mains.

The electrical connection to the power grid must be carried out by a qualified electrician. Based on professional training, knowledge of the relevant standards and experience, he/she can assess the installation steps and identify any possible dangers.

On the building side, it is necessary to provide RCD type A circuit breaker (30 mA AC). The wallbox already has an integrated DC residual current detection. The overcurrent protection device of the electrical supply line must also be dimensioned and installed by an electrician.

Observe the 5 safety rules for electrical work:

1. disconnect;
2. secure against being switched on again;
3. determine the absence of voltage;
4. ground and short-circuit;
5. cover or fence off adjacent live parts.



**NOTE:** After connection or reconnection, the electrotechnical equipment must be tested in accordance with the applicable standards.



**NOTE:** The operator must provide protection against the lightning.



**NOTE:** The electrician is responsible for dimensioning the cables according to the building conditions.



**DANGER! Voltage!** The connection is only to be carried out in a voltage-free state and without a vehicle connected as well as by a qualified electrician.

5 connection terminals are provided for connecting the power cable. The corresponding assignment is printed on the circuit board (PE – N – L1 – L2 – L3).

In general, the following colors are set per phase:

Marking	Color	Designation	1/3 phase
PE	Yellow-Green	Protective	1 / 3
N	Blue	Neutral	1 / 3
L1	Brown	Head of Phase 1	1 / 3
L2	Black	Head of Phase 2	3
L3	Grey	Head of Phase 3	3

 **NOTE: Even if the colors are set this way, it may be different on site. There are also additional differences here. Therefore, always check whether the rotation field is correct.**

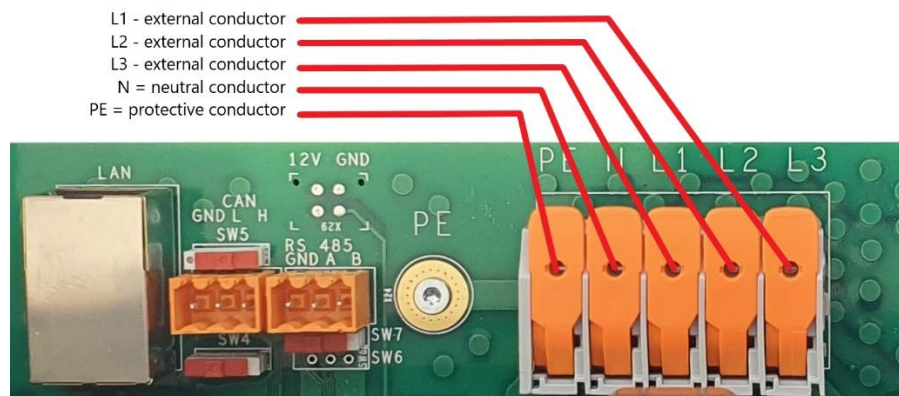

Prepare the connection cable by shortening the individual wires to the correct length and insulate the individual wires with the stripping pliers. The stripping length of the individual wires is 11-13 mm.

Insert the individual wires of the main cable into the associated terminals. To do this, open the orange lever first, insert the wire and close the lever again.

The maximum cross-section per wire and terminal is as follows:

Single-wire conductor	10 mm <sup>2</sup> / 8 AWG
Fine wire conductor	10 mm <sup>2</sup> / 8 AWG
Fine wire conductor with wire end sleeve with plastic collar	6 mm <sup>2</sup>

If the wallbox is connected with one phase, please always use the connection terminal L1 of the wallbox and leave L2 and L3 free. This also applies to the connection with two or three phases. In this case, the connection terminal L1 must be connected, and the rotating field observed. Failure to do so displays an error (Error ID-0100).

In order to counteract an unbalanced electrical load when installing on a three-phase alternating current network, when installing several wallboxes we recommend connecting these in phase alternation.

The mostly single-phase charging of hybrid vehicles can lead to an uneven load on the outer connectors of a three-phase alternating current network if the phase connection is identical.

The following connection diagram is recommended, taking into account the local infrastructural requirements:

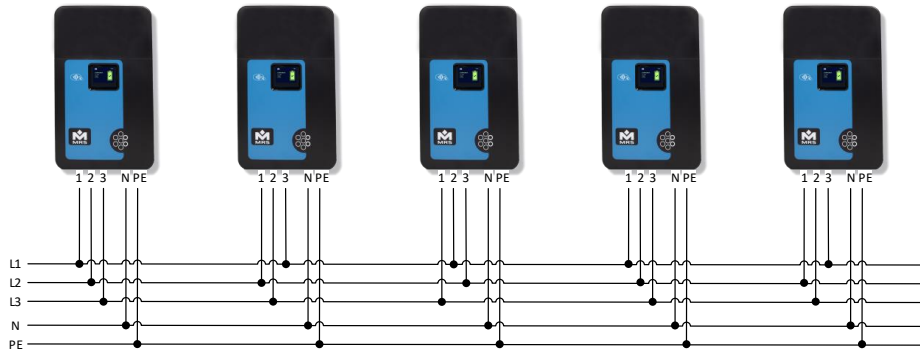

**NOTE: The simultaneity factor cannot be reduced by an alternating connection!**



**NOTE: Check that all wires have a firm fit in the terminal block.**

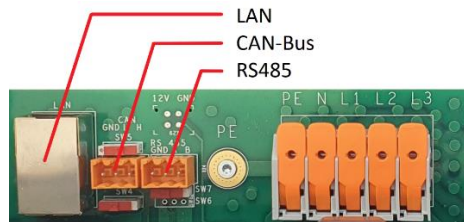

You can connect the wallbox to your LAN network via the LAN interface. To do this, use an appropriate network cable.

Use the connector included in the assembly kit to connect the CAN bus cable. To do this, the cable ends must be stripped to a length of 7 mm. When connecting, pay attention to the pin assignment shown in the figure.

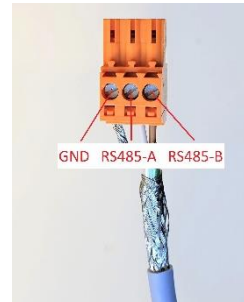
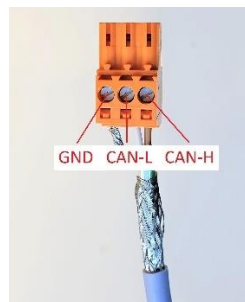

If available, connect the shielding as shown.

Pay attention to the correct termination of the connecting cable as well as the master and slave setting of switch SW4. Please note the information in the chapter "*Loadbalancing*".

When connecting the RS485 interface proceed in the same way as to connect the CAN bus. The pin assignment of the RS485 interface is shown in the graphic above. Switch SW7 is available for terminating the RS485 interface.



**NOTE: After connection or reconnection, the wallbox must be tested according to VDE 0105-100.**

### ***Mounting the top cover***

After the wallbox is mounted and connected to the mains, the top cover must be put on and fixed tight.

Make sure the seal is in the correct fit before placing the cover. Insert the cover first at the bottom before it can snap into place at the top of the 2 locking positions.

Finally mount the two screws on the top cover 3.5 x 12 T15 left and right into the holes provided.

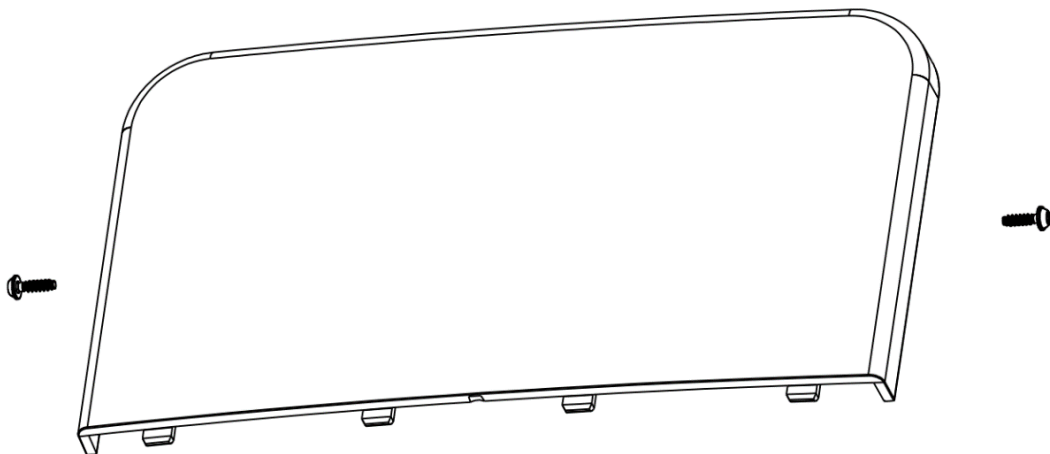



## Setting up the wallbox

### Connection

Connect to the wallbox Wi-Fi network using a computer, smartphone or tablet. The network will appear with the name (SSID) "Wallbox\_XXXXXXX" as soon as you are close to the wallbox. A password is not required here.

- In your browser, go to the following address: <https://192.168.42.1>
- Enter the full address <https://192.168.42.1>. If you enter the address without "https://", for example, the Internet browser may carry out a search query on the Internet instead of calling up the user interface.
- If necessary, confirm the browser's security warning and continue.
- Log in to the home screen with your credentials.

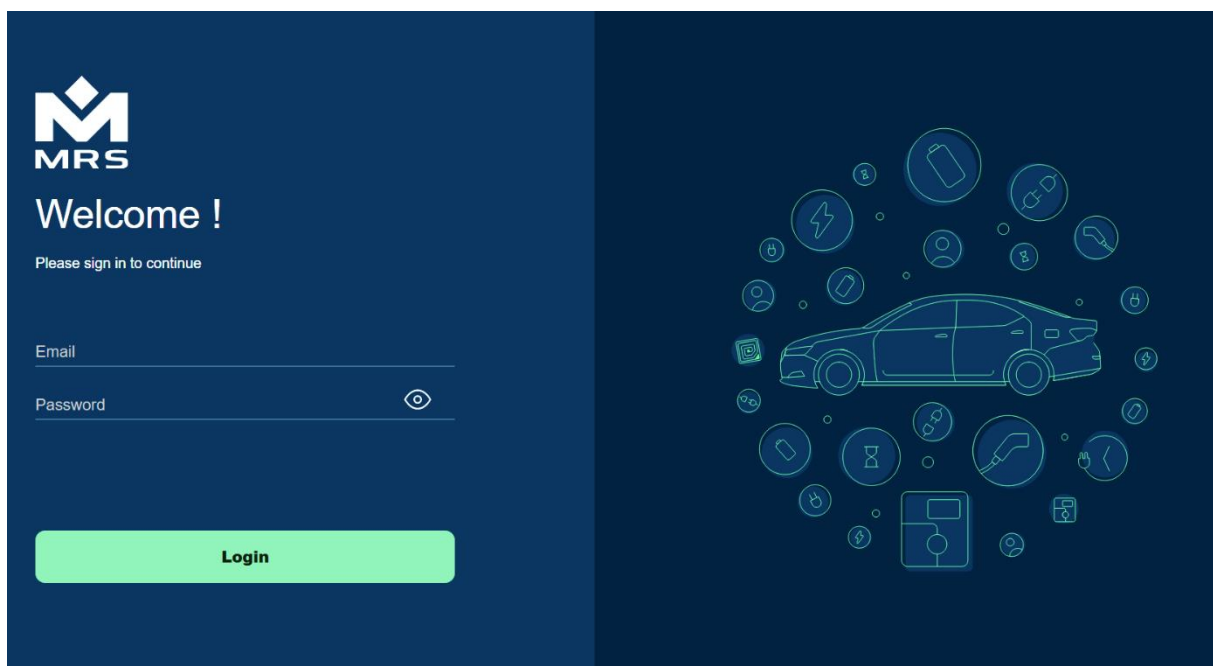

**INFORMATION!** You can find your access data on a separate sheet issued together with this manual.

You are now on the dashboard. To connect the wallbox to your Wi-Fi network or to make settings for the connections, select the "Connectivity" tab on the left side of the menu bar:



Make the settings for connecting your wallbox:

- Wi-Fi
  - Here you can set up access to your personal Wi-Fi network. Enter the access data for your Wi-Fi network in the "Username or Email" and "Password" input fields.
- Wi-Fi AP
  - Here you can edit the access data of the locally provided Wi-Fi of your wallbox. Be sure to make a note of the changes! It is recommended that you keep the settings. If you lose your self-selected access data, the wallbox can still be reached via LAN or, if already set up, via your home Wi-Fi network.
- Ethernet
  - Here you will find information about the LAN interface. If you have connected the wallbox via a LAN cable, you can find your IP address and connection information here.

If you have connected the wallbox to your home network (*Ethernet* or *Wi-Fi*), you can now call up the wallbox via its IP address. To determine the address of the wallbox, select the connection you have already set up under the menu item "*Connectivity*".

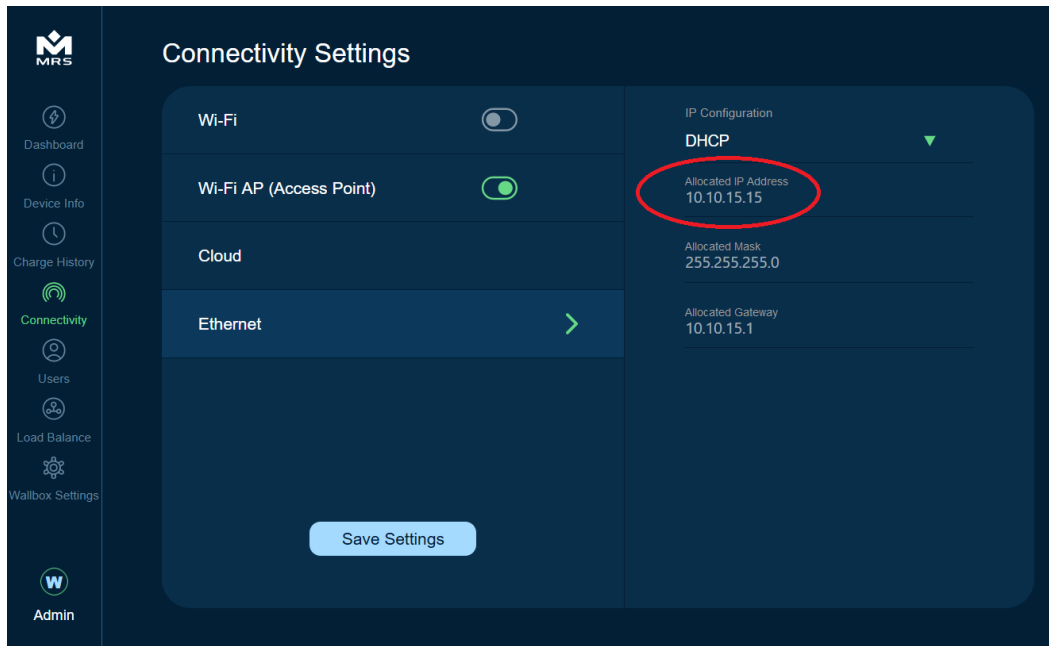

The IP address of your wallbox (*Allocated IP Address*) is displayed here. To get to the web interface of the wallbox, follow these steps:

1. Open your web browser.
2. Enter the following address in the address bar: [https://“IP address”](https://10.10.15.15) (use the *Allocated IP address* of your wallbox, e.g. <https://10.10.15.15>).
3. If necessary, confirm the browser's security warning and continue.

### ***Enable automatic updates***

It is recommended to enable the "*OTA support*" option when setting up your wallbox for the first time. This enables updates to be carried out automatically. You can activate this setting under the menu item "*Connectivity*" under the heading "*Cloud*". In order to use the function, you must read the data protection information and activate the function.

### ***Enable data transfer***

It is recommended to activate the "*Maintenance data*" function as well. This enables us to help you, should complications arise and find a solution via remote diagnosis. You can also activate this setting under the menu item "*Connectivity*" under the heading "*Cloud*". In order to use the function, you must read the data protection information and activate the function.

## Create users

It is recommended to create the desired users of the wallbox directly after the initial registration. To do this, navigate to the tab "Users" via the menu items on the left side.



Here you can create a user by clicking on the field "Add User".

1. First enter a name, an e-mail address and a password. Entering the phone number is optional. Continue with: "Next step".
2. You now have the option of setting the user's authentication. This step is optional and can be skipped. If authentication via RFID is not needed, you can deactivate it under "Wallbox Settings".

Click the "Add New RFID" icon. The wallbox changes the display and prompts you to hold the RFID card/tag within 60 seconds on the RFID icon.

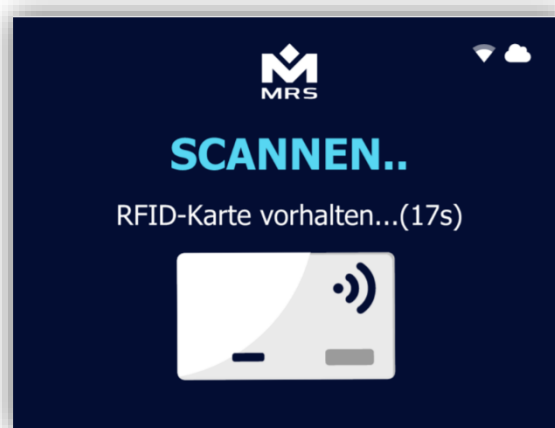

1 Visual display of the wallbox

Hold the antenna of the RFID card in front of the marked point on the wallbox (not on the display). Continue with: "Next step".

3. You now have the option of setting the user's authorization. To create a user, select the type "Regular User", "Technical Support" or "Admin" under the "User Role" selection window. Complete the setup of the new user with "Add User".

Now you can log in to the wallbox with the newly created user (username or e-mail address and password). The authorized functions are now available according to the selected user role.

### User types

The following overview provides information about the user authorizations:

Rights \ User	Regular User	Technical Support	Admin
Charging	✓	✓	✓
Change your own user data	✓	✓	✓
View your own charging history	✓	✓	✓
Interrupt the loading of other users	✗	✓	✓
Make / read settings	✗	✓	✓
Run updates	✗	✓	✓
Create, edit, delete users	✗	✗	✓
View the entire charging history	✗	✗	✓

### RFID cards/tags

The wallbox is compatible with a variety of common RFID cards and tags. RFID tags/cards according to ISO 14443-3A (Mifare Classic) are recommended. When using individual cards/tags, please ensure that you hold the card/tag antenna in front of the marked area.

**i** **INFORMATION!** Some RFID cards/tags internally have smaller antennas than their actual size. By moving the card/tag over the marked area, make sure that the antennas are kept close enough to the reader. Make sure the antenna is held close enough to the reader.

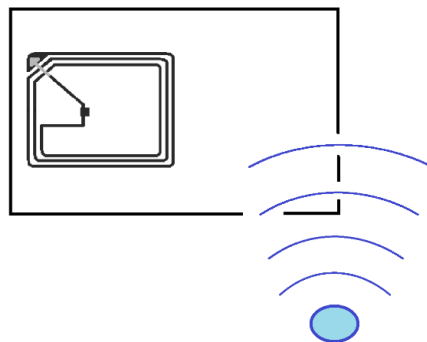

RFID cards/tags can be set up when new users are created. You can add or change additional cards/tags to a user also later. To do this, go to the "Users" menu item, select the desired user and, as described in the chapter „Create users“ assign a new card/tag.

## General settings

Under the menu item "Wallbox Settings" you can make the basic settings of your wallbox. Which includes:

- *Name* – naming your wallbox with it's own name;
- *Time* – time settings;
- *Geo Location* - Automatic determination of the location (determination of the correct time zone);
- *Charge Schedule* - time-dependent restriction of charging power;
- *Display brightness* – setting the brightness of the local display;
- *Language change* – setting the language of the local display;
- *RFID Card* – Activate and sign up the RFID tag to unlock the wallbox;
- *Load balancing* – configuration for the operation of multiple wallbox;
- *Password change* – changing the user login password;
- *Open Charge Point Protocol (OCPP)* – integration configuration for backend systems;
- *Power Limitation* - permanent power reduction.



**INFORMATION!** The menu items displayed vary according to the type of user logged in. See chapter [User types](#)

## Power reduction

This chapter describes how you can reduce the power of your wallbox. On the one hand, you have the permanent setting, on the other hand, you can define a time-dependent performance restriction.

For a permanent power reduction, navigate to the "Power Limitation" section under the "Wallbox Settings" menu item. For a permanent setting, enter the desired power under the item "Maximum Power Consumption (kW)".

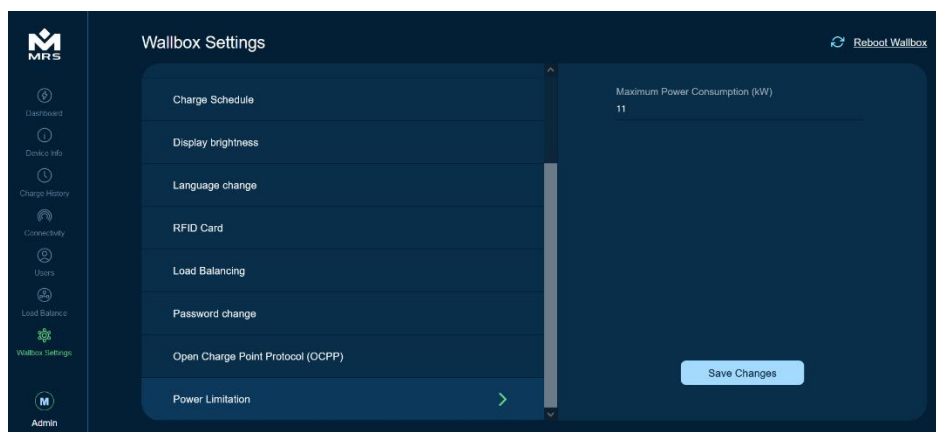

If you want a time-based limitation of the charging power, navigate to the "Charge Schedule" section and activate the "Schedule" option. Create a schedule using the "Create New Schedule" feature. Follow the menu navigation and confirm your entries with "Save Schedule". Please note that the power specifications refer to the three-phase operation of the charging station!

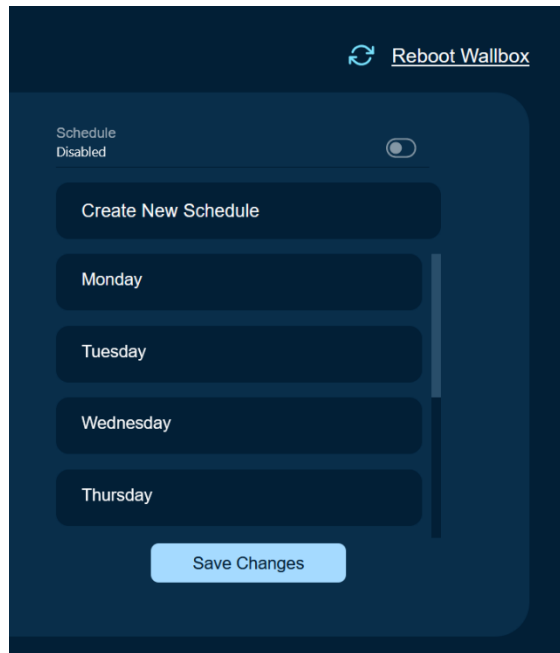

After you have made the permanent or time-dependent settings, click on the "Reboot Wallbox" button to apply the settings. This will restart the wallbox.



**NOTE: The power that can be configured here refers to the three-phase connection of the wallbox!**  
In single or two-phase operation, the power is reduced according to the number of phases.

## Charging History

On the homepage you will already see a section called "Activities" and another section called "History". The charging processes that have been carried out are displayed here. Please note that you will only see the charging processes that correspond to your authorization. Only a user with the administrator rights can see other users' charging activities.

If you have deactivated the "RFID Card" feature, the charging processes will not be assigned to any user and will be available here to see for everyone.

A more detailed representation of the charging history can be found under the menu item "Charge History". A data export of the recorded charging processes is available here. Please note that only a user with administrator rights can view and export the charging activities of other users.

For an export, select the "Download" button, then a time period and user for whom you want to export the downloads.

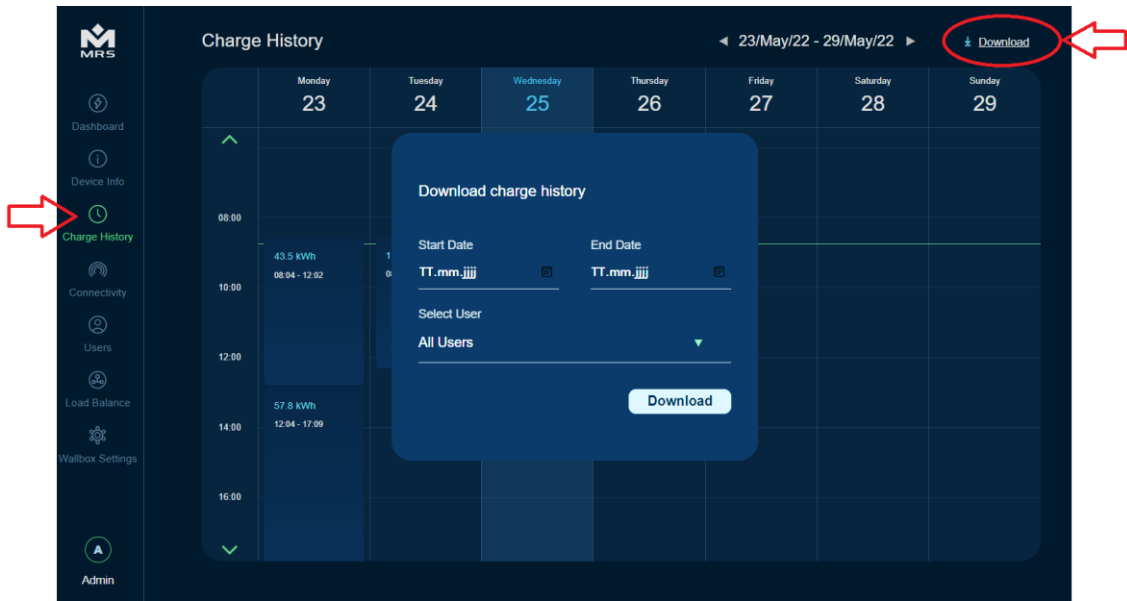

By pressing the download button you will be forwarded to the data export in the form of a PDF file.

### Charge History

Device ID	C82B9688026C
Date	26.4.2022 14:40:53
Export Period	29.3.2022 - 29.3.2022
Total Consumption	0 kWh
User	All Users

User	Start Time	Duration	Energy Consumption
Unknown User	29.3.2022 17:38:57	42s	0.0 kWh
Unknown User	29.3.2022 17:38:31	22s	0.0 kWh
Unknown User	29.3.2022 17:38:06	22s	0.0 kWh



**INFORMATION!** In order to be able to carry out a data export, you need an internet connection for the wallbox which you can use for the [Data transfer activation](#).



# Loadbalancing

To operate several wallboxes in one network and at the same time protect the infrastructure from overloading, you can use the automatic load balancing function. All you have to do is connect the wallboxes via the CAN interface. When using the CAN bus, pay attention to the correct termination of your wallboxes and the maximum cable length of the bus line. To achieve the maximum distance between the bus nodes, use a cable that meets the requirements of ISO 11898-2 if possible. You can easily terminate the wallbox via the switch position of switch SW5. To do this, slide switch SW5 to the right side:

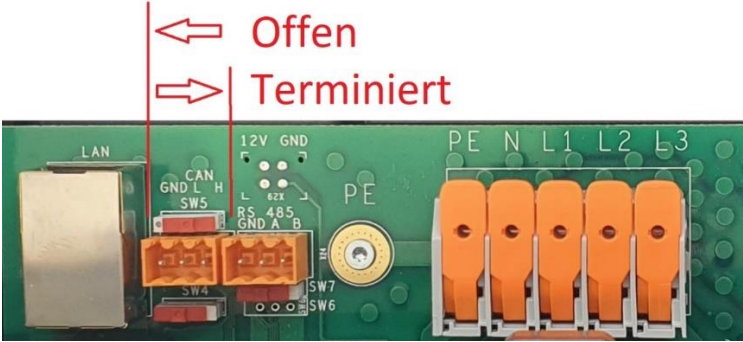

Connect your wallboxes with a string cable from one device to the next one. The first and last bus participant must be terminated. All other wallboxes that are not used at the beginning or end of the line must not be terminated.

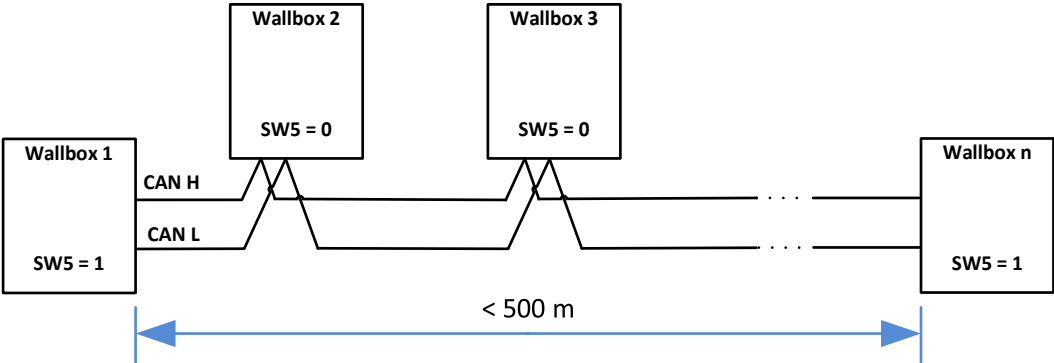

If it is necessary to approach a wallbox via a stub cable, it is important to keep the line as short as possible. Stub cables should not be longer than 10 meters. Stub cables reduce the maximum bus range.

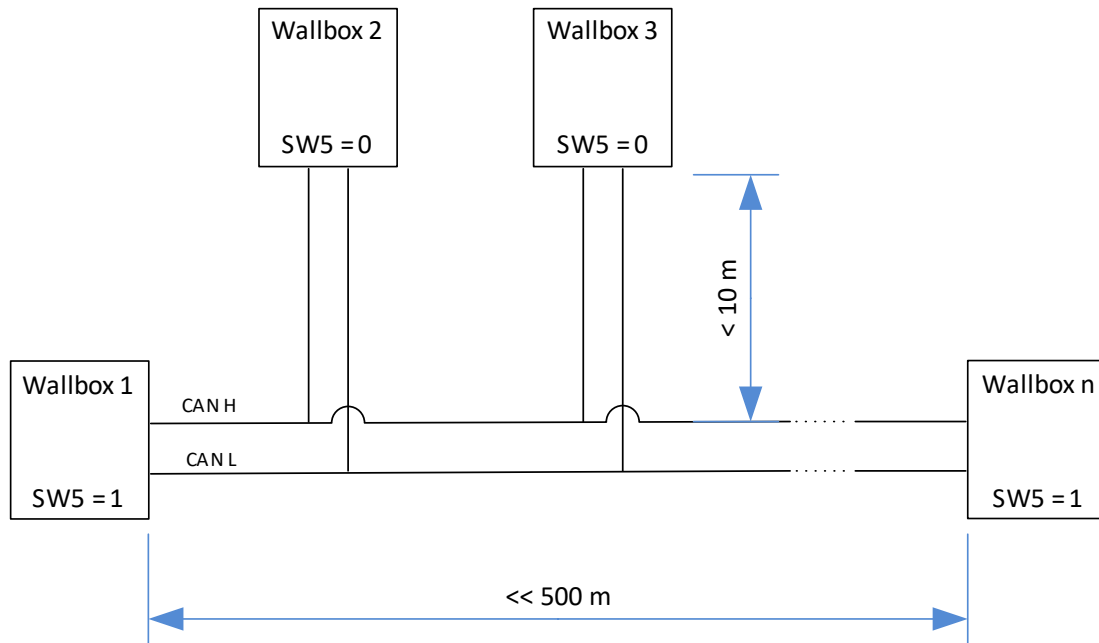

**INFORMATION!** A charging network can consist of up to 16 wallboxes. Make sure that only one wallbox acts as the master!

### Master / Slave set-up

Activate the "Load Balance" feature in the "Wallbox Settings" menu item and enter the charging power available for the charging network. Here you are asked for the total power that is to be divided among all the wallboxes belonging to the network. After making this setting, restart the wallbox using the "Reboot Wallbox" button.

Check the switch position (SW4) of the master and slave wallboxes according to their use:



If the switch is in the right position, the wallbox is configured to operate as a master. In the left position, the wallbox can be operated as a slave.

## Master configuration

In order to operate your wallboxes in a network, first start with the configuration of the master. To do this, select the "Add New Device" button under the "Load Balance" menu item. To create a master, enter the number 0 in the "Slave ID" field. The "Device ID" can be found under the menu item "Device Info". Then select a priority with which the master wallbox should charge and confirm with the "Add Device" button.

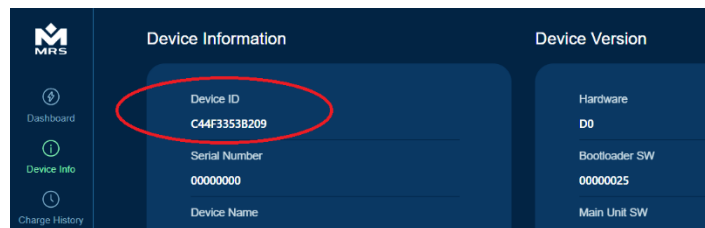
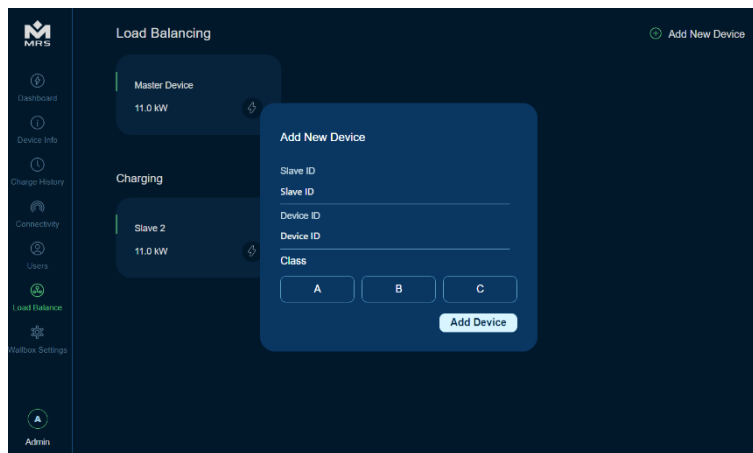

## Slave configuration

Now you can add more slave wallboxes. To do this, repeat the steps beginning with "Add New Device". Enter consecutive numbers for the other slave wallboxes in the "Slave ID" input field. You can assign IDs from 1 to 15 for this. When configuring, make sure that priority A is only assigned to one wallbox!

## Slave deactivation

The slave can be deactivated on the master. If you select the corresponding slave, an "Activate / Deactivate" button appears. The slave can also be deleted here using the trash icon.

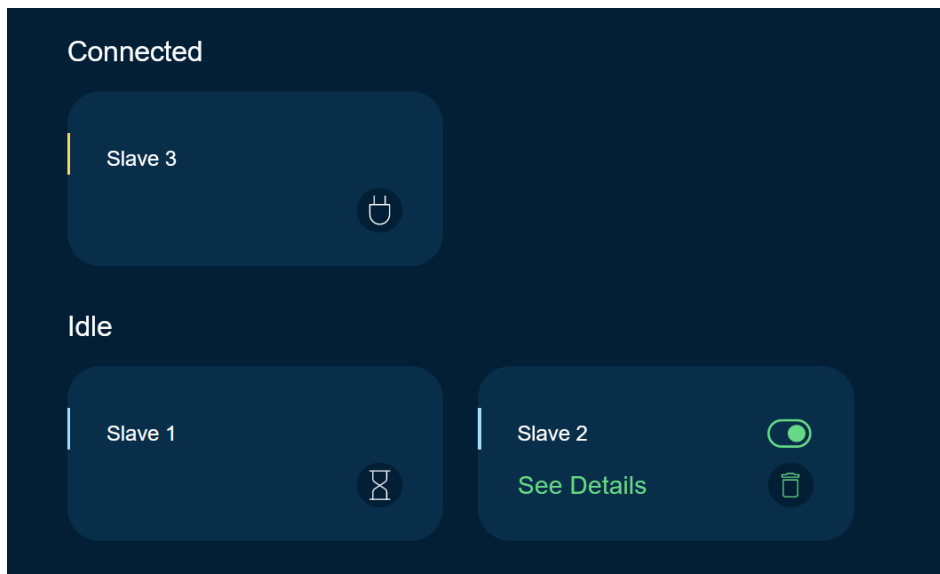

If a slave is deactivated via the master, it is displayed as follows (see Slave 2):

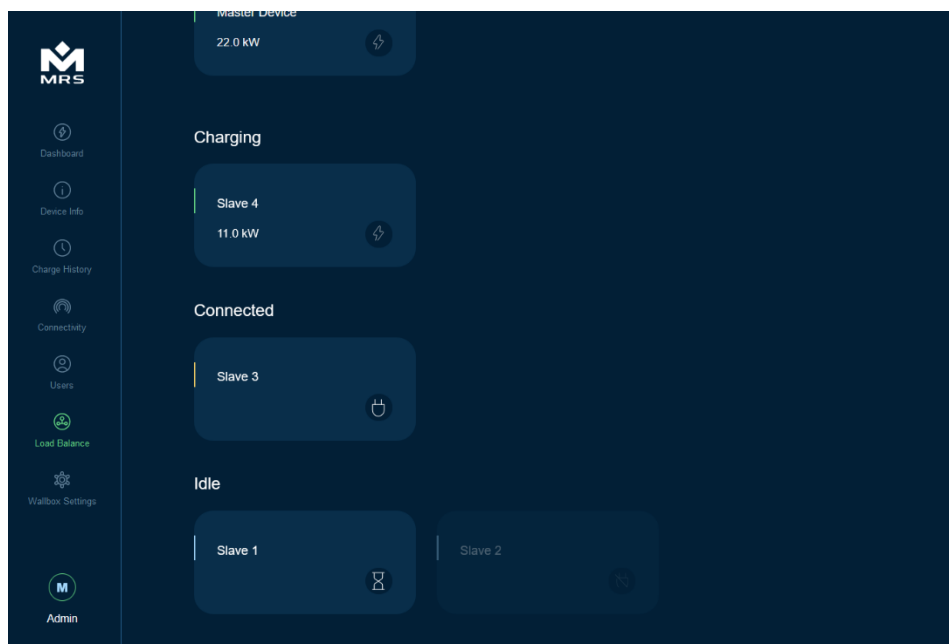

### ***Prioritization and load sharing***

When load balancing the wallbox, different priorities can be assigned to the individual wallboxes. Priorities A, B and C are available.

**Priority C** is preset by default. In this configuration, all wallboxes have the same priority. This means that all the power available in the system is distributed equally to the wallboxes with priority C.

A **Priority B** wallbox has twice the power available compared to a Priority C wallbox:

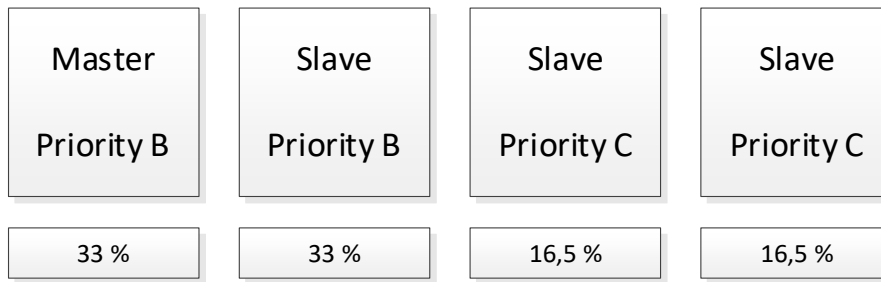

If a wallbox is given **Priority A**, it will be allocated all of the energy required when charging is requested. The other participants are throttled according to their priority.



**INFORMATION!** Ensure that not more than one wallbox in a charging network is configured with the priority A!

# OCPP

To connect the wallbox to a backend system via OCPP v1.6, you can enter the access data provided by your backend provider under the “*Open Charge Point Protocol (OCPP)*” option in the “*Wallbox Settings*” section. By default, Port 443 is used for this. You can get the exact connection parameters from your backend provider.

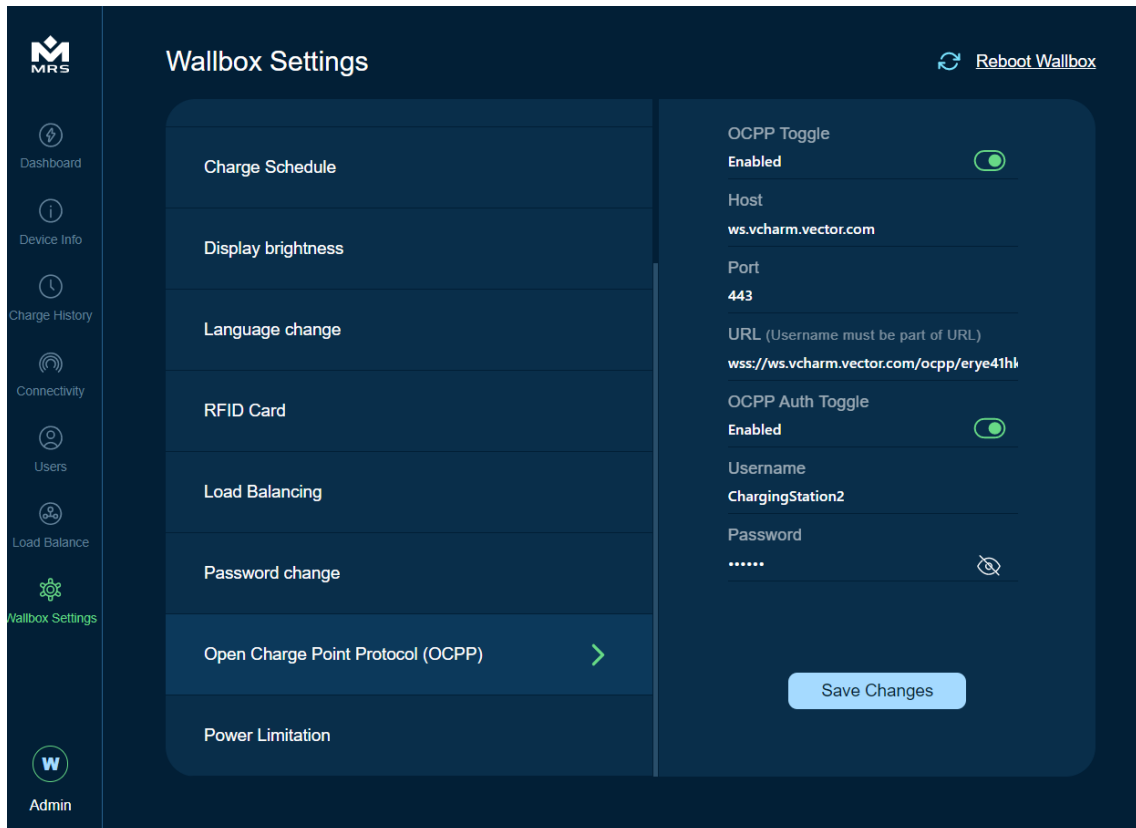

# Operating instructions

## General

The wallbox is equipped with a pre-assembled type 2 socket according to the EN 62196-2 standard. Before using the wallbox, the suitability of the vehicle for charging with it must be checked. Park the electric vehicle in such a way that you can easily reach the charging connection on the vehicle and the wallbox with the charging plugs of the charging cable.

Furthermore, it must be ensured that the charging cable cannot be run over by your own vehicle or another vehicle, while it is being charged, in order to avoid damage to the cable.



**INFORMATION!** Plug only a matching cable into the socket of the wallbox and the vehicle. Do not use force!



**INFORMATION!** During the charging process and in standby mode the charging cable must be laid in such a way that it is not a trip hazard and cannot be run over by other vehicles.

## Standby mode



After the wallbox is properly assembled and installed according to the instructions, it will start into standby mode. The wallbox shows the following display:



If the RFID authentication has been deactivated in the settings, the wallbox shows the following display:



A connection icon will also appear in the upper right corner of the display.

Icon	Designation
	Wi-Fi
	Wi-Fi AP (Access Point)
	Cloud Connection

The Wi-Fi, Wi-Fi AP, or Cloud icon does not appear automatically when enabled. The respective symbol appears on the display when a connection has been successfully established and remains visible on the display as long as the connection is active.

The wallbox is ready for charging.

### ***Vehicle connected***

As soon as authentication takes place and a vehicle is connected to the wallbox, the display changes. Now the charging process can be started if this has not already happened automatically.

If the charging process is automatically started by the vehicle, this display is only visible for a short time before it switches to the next display mode. If time-dependent charging is set up by the vehicle, this display mode is visible until the start of the charging, which is controlled by the vehicle.





## Charging

As soon as the charging process starts, the vehicle locks the plug of the charging cable in its socket. This prevents the charging process from being interrupted prematurely by unplugging the charging cable.

The charging process is started by connecting the vehicle to the wallbox. If the process does not start automatically, please check whether the vehicle has also released the charging process. Some vehicles offer the possibility to start charging at a certain time and do not start charging beforehand.

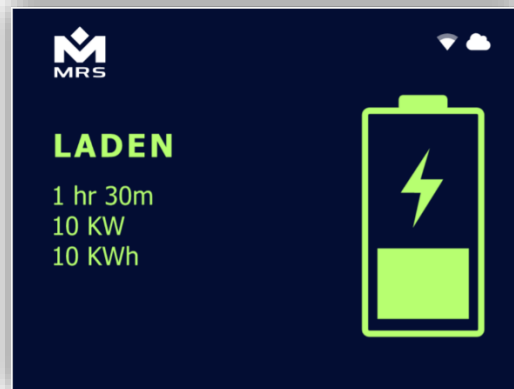

On the left side of the display, you will see 3 values that allow you to observe the charging process.

The top value provides information about the charging time, the time from the start of the charging process to its completion is counted. The charging time is maintained if the connection with the vehicle is not broken. If the charging process is stopped from the vehicle in the meantime, this counter also stops. It continues to count the time as soon as the charging process is resumed. At the end of the charging process, only the entire charging time is displayed. If the cable is unplugged from the car, the time counter is reset.

In the middle there is the power indicator. When the charging process starts, the value will increase until the current charging power is displayed. The total number of all active phases is displayed here. If the vehicle is charged with one phase, the maximum value is 7.4 kW. If the connected vehicle uses 2 phases for charging, a maximum of 14.7 kW is possible. When charging with 3 phases, the maximum is 22 kW.

Depending on the quality of the infrastructure and grid fluctuations, there might be deviations from the expected 230 V AC at the connection point of the wallbox.

This affects the readout of the charging power. This will then not show the expected value of 22 kW, but the actually measured consumption of e.g. 21.6 kW. This is not a malfunction.

Other options for limiting the maximum charging power can be made through the configuration of the [load management](#) or through the general settings of the wallbox.

The last value provides information about the sum of the charged energy during the charging process. In the beginning of the charging process the value is 0 kWh and will then increase slowly or faster depending on the available charging power. Just like the charging time, this value is also maintained when the vehicle has paused charging and continues to count when charging continues. The value is not reset until the charging cable is unplugged from the car.

## ***End of charging***

When the charging process is finished, this is indicated with a tick in the battery on the display. Charging may be terminated when the battery is fully charged or when the vehicle has stopped or paused charging. If the charging process is continued after a pause, the display changes back to the [charging process](#). The values are only reset after the charging process has ended and the vehicle has been disconnected from the wallbox.

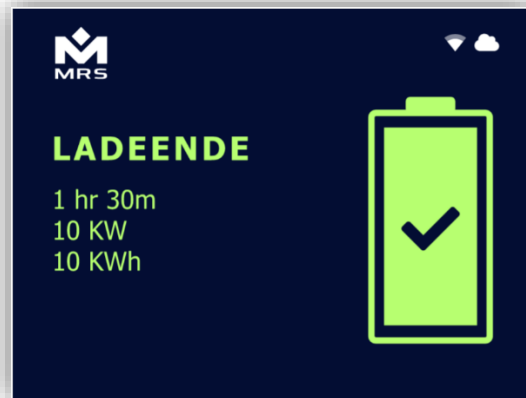

# Maintenance, troubleshooting and decommissioning

## Maintenance

The wallbox is maintenance-free.

### Manual updates

If your wallbox does not have an Internet connection, you can also install updates locally. To do so, download the current software from the website <https://www.mrs-electronic.com/solutions/e-mobility>. Connect to the wallbox. If the wallbox has not been integrated into a network, use the WLAN provided by the wallbox. Log in to the wallbox as described in chapter [Connection](#) and navigate to the „Device Info“ menu item. Click on the "Firmware update" button and select the previously downloaded software. The installation progress is then displayed.

### Cleaning

Clean the wallbox with a slightly damp cloth. Please do not use abrasive cleaning agents that can damage the surface and the display.



**NOTE!** Do not use a pressure washer or steam jet for cleaning the wallbox.

Check at regular intervals the function of the residual current circuit breaker, provided on the building side.

Check at regular intervals if the wall mounting is still strong enough and no parts of the wallbox are damaged (e.g., housing, cables, plugs).





**WARNING!** If the connection cable, the wallbox or the charging cable show visible damage, you must not continue to use them.  
Please shut down the wallbox and then consult a qualified electrician.

### Error diagnosis

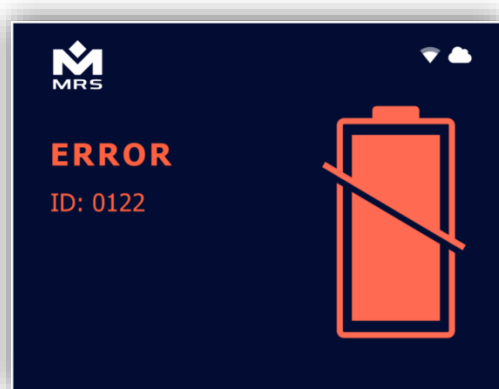
If an error occurs, the wallbox signals it with a beep and a corresponding message on the display. In addition, an error ID is displayed, with the help of which the malfunction can be determined more precisely. The following figure and table provide information on the possible errors and how to fix them:



Error ID	Description	Troubleshooting
0001	A fault current has been detected	 <b>DANGER!</b> Disconnect the power supply to the wallbox and secure it against being switched on again. Then disconnect the charging cable from the vehicle. Contact the electrician who carried out the installation of the wallbox.
0002	Vehicle error detected	The vehicle does not communicate as expected. Check if an error is emitted by the vehicle. If this is not the case, disconnect the charging cable from the vehicle. Restart the charging process. If the error persists, refer to the operating instructions of your vehicle and contact your supplier of the wallbox or the vehicle brand dealership. Provide the corresponding error IDs from the wallbox and the vehicle.
0004	Communication error of load management via CAN	The load management has detected an error. The master cannot be reached via Ethernet or the CAN bus. Check the configuration of your wallbox. If the wallbox is not operated in a charging network, also check the position of slide switch SW4.
0008	Communication error via Ethernet	The wallbox could not connect to the internet. Check your network settings or use offline operation.
0010	Temperature error	The temperature is outside of the wallbox manufacturer's specification. Check the requirements from the chapter " <i>Installation site requirements</i> " and the temperature range on the nameplate. Let the wallbox cool down and start the charging again. If the error persists, refer to the operating instructions of your vehicle and contact your supplier of the wallbox or the vehicle brand dealership. Provide the corresponding error IDs from the wallbox and the vehicle.
0020	Compatibility error	The connected vehicle has requested ventilation. This operating mode is not supported. See the chapter " <i>Intended use</i> ".
0040	Vehicle error detected	The vehicle does not behave as expected and exceeds the permissible charging current. Disconnect the charging cable from the vehicle. Restart the charging process. If the error persists, refer to the operating instructions of your vehicle and contact the vehicle brand dealership or your

		wallbox supplier. Provide the corresponding error IDs from the vehicle and the wallbox.
0080	Internal error detected	Disconnect the charging cable from the vehicle and start the charging process again. If the error persists, refer to the operating instructions of your vehicle and contact your supplier of the wallbox or the vehicle brand dealership. Provide the corresponding error IDs from the wallbox and the vehicle.
0100	Installation error detected	The installation of the wallbox is incorrect.  <b>NOTE:</b> An inspection of the installation by an electrician is required. The right rotating field must be observed!
0200	Internal error detected	Disconnect the charging cable from the vehicle. If necessary, start the charging process again. If the error persists, refer to the operating instructions of your vehicle and contact your supplier of the wallbox or the vehicle brand dealership. Provide the corresponding error IDs from the wallbox and the vehicle.
0400	Vehicle error detected	The charging cable could not be locked. Make sure the charging cable plug is fully inserted into the charging socket of the wallbox and that the charging cable is a compatible one. Restart the charging process. If the error persists, refer to the operating instructions of your vehicle and contact your supplier of the wallbox or the vehicle brand dealership. Provide the corresponding error IDs from the wallbox and the vehicle.
0800	Vehicle error detected	An emergency shutdown of the vehicle was detected. This can have different causes. Please refer to the vehicle report or consult the vehicle brand dealership.  <b>NOTE:</b> Please contact your electrician to check the installation.
1000	Wrong charging cable detected	Check the connected charging cable. The charging cable does not meet the requirements of IEC 61851.

Errors caused on the connection side can be deleted after restarting the wallbox, provided the error has been fixed. A restart takes place after a brief voltage-free state (switching off the fuse).

Errors that originate from the connection to the vehicle can be reset by unplugging the charging connection to the vehicle.

### **Reset**



**WARNING!** The wallbox may only be reset to the factory settings by a qualified electrician.

Use slide switch SW4 to reset the wallbox to factory settings. You can find the switch here:

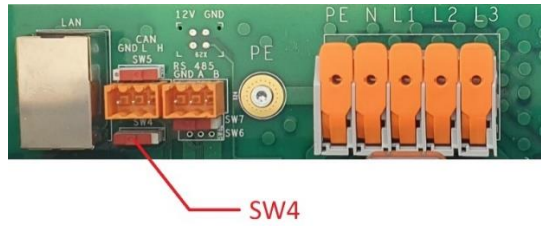

The slide switch SW4 has to be toggled ten times. The timeout for each toggle is five seconds. If there is no toggle within five seconds, the toggle counter is reset.

After ten toggles, a five-second beep sounds. After the long beep, a sequence of short beeps will continue for five seconds. During these five seconds, the slide switch SW4 must be moved one more time in the opposite direction.

Now the reset starts, which is signaled by repeated long beeps.

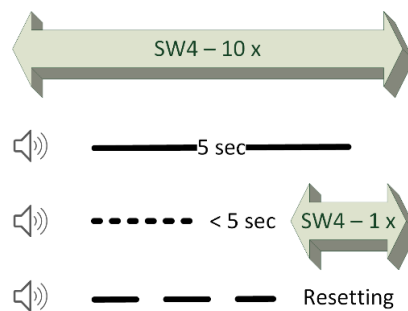

**INFORMATION!** After the reset, the original login data from the operating manual must be used.

All data and settings of the wallbox are deleted and reset to the factory status.

## Decommissioning

Decommissioning of the wallbox is necessary if one of the below happens:

- serious malfunctions;
- visible damage;
- dismantling.



**DANGER!** The decommissioning may only be carried out by a qualified electrician.

For this purpose, the wallbox must be disconnected from the mains, the corresponding supply line in the building fuse box must be switched off via the circuit breaker and the residual current circuit breaker and secured against being switched on again.

Then remove the wallbox from the wall or the surface by loosening all the screws.

## Disposal instructions



The symbol of the crossed-out waste bin means that electrical and electronic equipment including accessories must be disposed separately from general household waste.

The materials are recyclable according to their marking. By reusing or recycling the old equipment, you make an important contribution to the protection of our environment.

## CE marking and declaration of conformity

Hersteller Manufacturer	MRS Electronic GmbH & Co. KG Klaus-Gutsch-Straße 7 D-78628 Rottweil Germany
----------------------------	--

Die alleinige Verantwortung für die Ausstellung dieser Konformitätserklärung trägt der Hersteller. This declaration of conformity is issued under the sole responsibility of the manufacturer.

Bezeichnung, Artikel-Nr. Product Name, Number	MCharger Connected S 22 kW P/N: 1.801.111, S/N: 401480
Richtlinien Directive	1. 2014/53/EU Radio Equipment Directive 2. 2011/65/EU + 2015/863 – RoHS Directive Status: compliant with exemptions (7.a,7.c-l)
Angewandte harmonisierte Normen, normative Dokumente, Spezifikationen Harmonised standards, normative documents, specifications	Health/Safety: <ul style="list-style-type: none"> <li>• DIN EN IEC 61851-1:2019-12 inkl. Berichtigung 1</li> <li>• EN 62311:2008-09</li> </ul> EMC: <ul style="list-style-type: none"> <li>• EN 55032:2015</li> <li>• EN 61000-6-3:2007/A1:2011</li> <li>• EN 61000-6-2:2019</li> <li>• IEC 61851-21-2:2018</li> </ul> EMC Radio part (RED): <ul style="list-style-type: none"> <li>• ETSI EN 301 489-1 V2.2.3:2019</li> <li>• ETSI EN 301 489-3 V2.1.2:2021</li> <li>• ETSI EN 301 489-17 V.3.2.0:2017</li> </ul> Radio: <ul style="list-style-type: none"> <li>• ETSI EN 300 328 V2.2.2:2019-07</li> <li>• ETSI EN 300 330 V2.1.1:2017-02</li> </ul>

Wir erklären hiermit, dass das oben genannte Produkt den einschlägigen Abschnitten der oben genannten Normen und Spezifikationen entspricht und den einschlägigen Harmonisierungsvorschriften der Europäischen Union entspricht. Alle Produktänderungen ohne vorherige schriftliche Zustimmung des Herstellers machen diese Aussage ungültig.

We declare that the product named above has been designed to comply with the relevant sections of the referenced standards and specifications and complies with the relevant European Union harmonization legislation. Any product modifications without prior written approval from the manufacturer will make this statement invalid.

Ort, Datum Place, Date	Name, Funktion Name, function	Unterschrift Signature
Rottweil, den 28.06.2022	Günther Dörgeloh, CEO	

## Technical Data

<b>Functions</b>	
Charging functionality up to 22 kW (1-3 ph)	✓
Easy installation	✓
Type 2 charging socket	✓
Status display showing charging duration, kW and kWh	✓
Acoustic warning buzzer	✓
RCD integrated (6 mA DC)	✓
SW-Update via OTA (LAN / WLAN)	✓
KfW eligible (Germany only)	✓
<b>Electrical characteristics</b>	
Charging mode	3
Nominal current (A)	max. 32 A, 1-3 phases
Grid network system	TN- TT
Input voltage (V AC)	230 (1 ph) / 400 (3 ph)
Grid frequency (Hz)	50
Overvoltage protection IEC 61010-1	CAT III
IEC 61140 protection class	I
Residual current monitoring	6 mA DC
<b>Radio characteristic frequencies</b>	
RFID	13.5 MHz
WLAN 802.11b/g/n	2.4 ~ 2.5 GHz
<b>Radio characteristic maximum antenna gain</b>	
WLAN	20 dBm
<b>Mechanical characteristics</b>	
Housing dimensions (W x H x D in mm)	266 x 441 x 137
Weight including packaging	5.3 kg
IP protection class	IP55
IK protection class	IK08
<b>Connection characteristics</b>	
Charging power	max. 22 kW
Output voltage (V AC)	230 (1 ph) / 400 (3 ph)
Installation cable	≥ 6 mm <sup>2</sup>
Cable feed	top, bottom, rear
Status display	2.4" color display
<b>Environmental Characteristics</b>	
Operating temperature (°C)	-25 °C to +60°C
Storage temperature (°C)	-40 °C to +80°C
Permissible max. relative humidity (%)	95 %
Max. altitude (m)	2000
<b>Certifications / Standard compliance</b>	
CE	✓
RoHS	✓
REACH	✓
WEEE	✓
IEC 61000-6-1 / 61000-6-3	✓
IEC 61851-1	✓
IEC 62196	✓
IEC 62955	✓



**Dimensions**

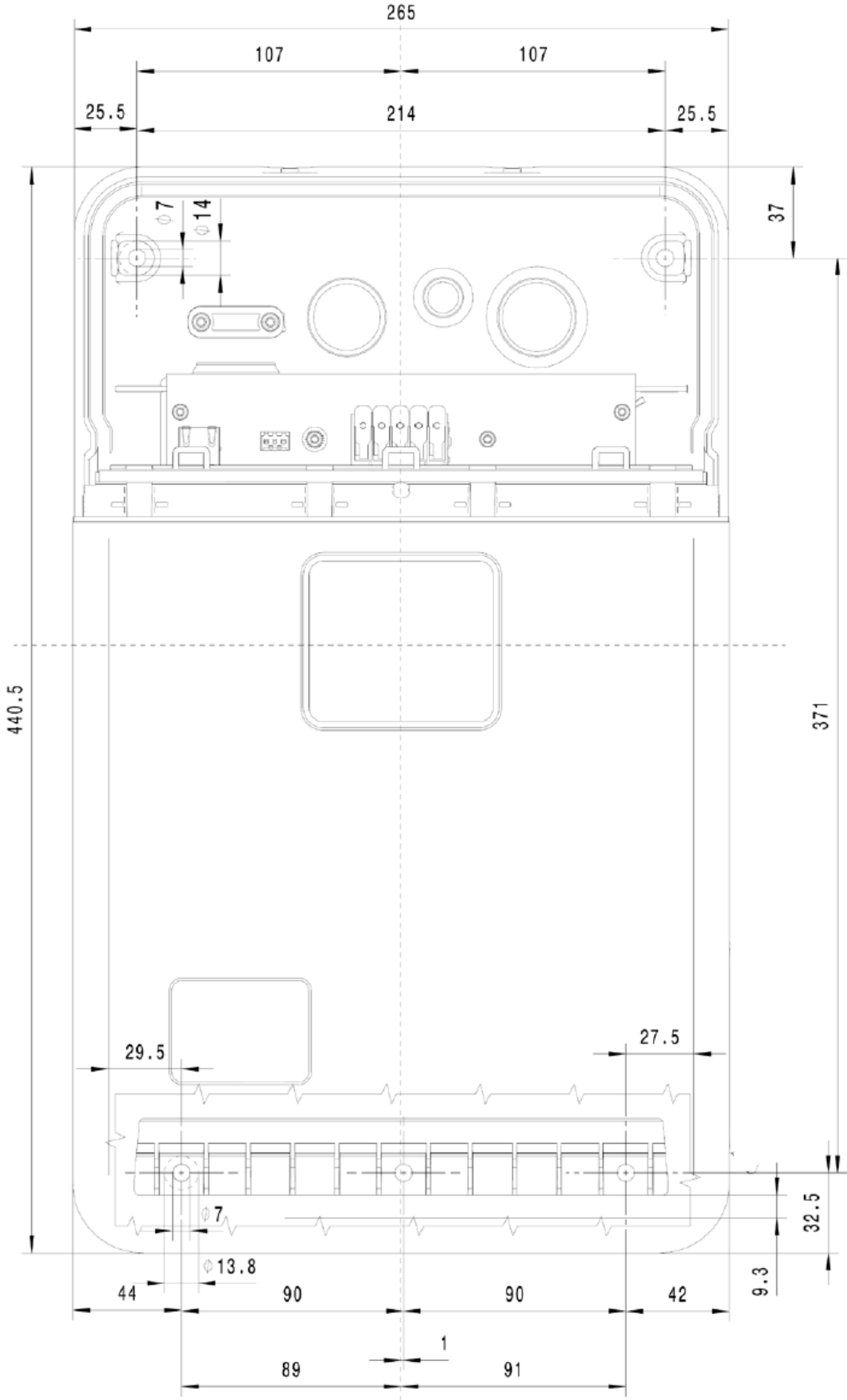

## Copyright

All rights reserved.

All information in this manual is subject to change without notice and does not constitute an obligation on the part of the manufacturer.

All illustrations in this manual may differ from the delivered product and do not represent an obligation on the part of the manufacturer.

The manufacturer assumes no responsibility for any loss and/or damage that occurs because of any information or misinformation contained in this manual.

## Contacts / SERVICE

Do you need any help? Please contact our support team:

Mon - Fr: 09:00 - 15:00 (CET)

Phone: +49 741 2807 1020

Email: [emobility@mrs-electronic.com](mailto:emobility@mrs-electronic.com)

Website: [www.mrs-electronic.com](http://www.mrs-electronic.com)



503516 – V.1.2